



Sovitron Interior Pvt.Ltd.



Model Name	URBANA-2104B / DL-OSL-2104BB-2
Description	Inground Light 2 Side light

Technical description	Image
-----------------------	-------

Dimension	Dia=90mm Cutout=64mm H=92mm
Frame	Aluminum die cast
Color Tempertaure	3000K
Power	4W
Total Luminous Flux	200 lm
Efficacy	50 lm/W
IP rating	67
Color Rendering	≥80
Mounting	Buried
Beam angle	2x60 °
Optics	Polycarbonate diffuser
Dimming	NON-Dimmable
Operating Voltage	220-240 VAC
Standard Lifetime	L70 minimum at 50,000 burning hours



Dimension diagram

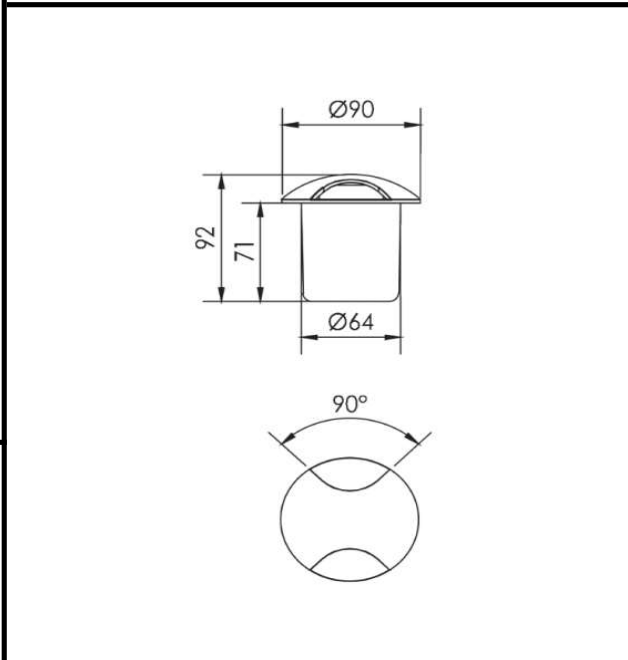

Remarks:-

Address: Plot #7 Saroorpur-Nangla Industrial Area,Ballabgarh-Sohna Road,Faridabad-121005
Email: info@sovitron.com